

SERVICE & OPERATING MANUAL

Original Instructions

Certified Quality



SAI GLOBAL

ISO 9001 Certified
ISO 14001 Certified

Member of
Hydraulic

Warren Rupp, Inc.
A Unit of IDEX Corporation
800 N. Main St.,
Mansfield, Ohio 44902 USA
Telephone (419) 524.8388
Fax (419) 522.7867
SANDPIPERPUMP.COM



©2017 Warren Rupp, Inc.

TA25

Metallic Construction Design Level 1



1: SPECS

2: INSTAL & OP

3: EXP VIEW

4: WARRANTY

SANDPIPER[®]
A WARREN RUPP, INC. BRAND

SANDPIPERPUMP.COM

Safety Information

IMPORTANT



Read the safety warnings and instructions in this manual before pump installation and start-up. Failure to comply with the recommendations stated in this manual could damage the pump and void factory warranty.



When the pump is used for materials that tend to settle out or solidify, the pump should be flushed after each use to prevent damage. In freezing temperatures the pump should be completely drained between uses.

CAUTION



Before pump operation, inspect all fasteners for loosening caused by gasket creep. Retighten loose fasteners to prevent leakage. Follow recommended torques stated in this manual.



Nonmetallic pumps and plastic components are not UV stabilized. Ultraviolet radiation can damage these parts and negatively affect material properties. Do not expose to UV light for extended periods of time.



WARNING
The use of non-OEM replacement parts will void (or negate) agency certifications, including CE, ATEX, CSA, 3A and EC1935 compliance (Food Contact Materials). Warren Rupp, Inc. cannot ensure nor warrant non-OEM parts to meet the stringent requirements of the certifying agencies.

RECYCLING

Many components of SANDPIPER® AODD pumps are made of recyclable materials. We encourage pump users to recycle worn out parts and pumps whenever possible, after any hazardous pumped fluids are thoroughly flushed.

WARNING



When used for toxic or aggressive fluids, the pump should always be flushed clean prior to disassembly.



Before maintenance or repair, shut off the compressed air line, bleed the pressure, and disconnect the air line from the pump. Be certain that approved eye protection and protective clothing are worn at all times. Failure to follow these recommendations may result in serious injury or death.



Airborne particles and loud noise hazards. Wear eye and ear protection.



In the event of diaphragm rupture, pumped material may enter the air end of the pump, and be discharged into the atmosphere. If pumping a product that is hazardous or toxic, the air exhaust must be piped to an appropriate area for safe containment.



Take action to prevent static sparking. Fire or explosion can result, especially when handling flammable liquids. The pump, piping, valves, containers and other miscellaneous equipment must be properly grounded.



This pump is pressurized internally with air pressure during operation. Make certain that all fasteners are in good condition and are reinstalled properly during reassembly.



Use safe practices when lifting

Grounding ATEX Pumps

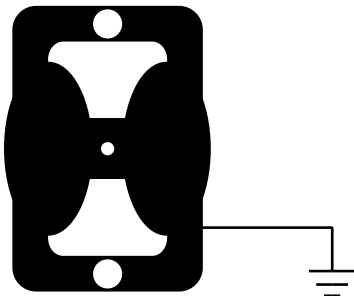

ATEX compliant pumps are suitable for use in explosive atmospheres when the equipment is properly grounded in accordance with local electrical codes. Pumps equipped with electrically conductive diaphragms are suitable for the transfer of conductive or non-conductive fluids of any explosion group. When operating pumps equipped with non-conductive diaphragms that exceed the maximum permissible projected area, as defined in EN 13463-1: 2009 section 6.7.5 table 9, the following protection methods must be applied:

- Equipment is always used to transfer electrically conductive fluids or
- Explosive environment is prevented from entering the internal portions of the pump, i.e. dry running

For further guidance on ATEX applications, please consult the factory.

Table of Contents

SECTION 1: SPECIFICATIONS1

- Materials
- Dimensional Drawings

SECTION 2: INSTALLATION & OPERATION ...5

- Recommended Installation Guide
- Troubleshooting Guide

SECTION 3: EXPLODED VIEW.....8

- Composite Repair Parts Drawing
- Composite Repair Parts List
- Material Codes

SECTION 4: WARRANTY & CERTIFICATES ..15

- Warranty
- CE Declaration of Conformity - Machinery
- ATEX Declaration of Conformity

Materials

Material Profile:

CAUTION! Operating temperature limitations are as follows:

	Operating Temperatures:	
	Max.	Min.
Conductive Acetal: Tough, impact resistant, ductile. Good abrasion resistance and low friction surface. Generally inert, with good chemical resistance except for strong acids and oxidizing agents.	190°F 88°C	-20°F -29°C
EPDM: Shows very good water and chemical resistance. Has poor resistance to oils and solvents, but is fair in ketones and alcohols.	280°F 138°C	-40°F -40°C
FKM: (Fluorocarbon) Shows good resistance to a wide range of oils and solvents; especially all aliphatic, aromatic and halogenated hydrocarbons, acids, animal and vegetable oils. Hot water or hot aqueous solutions (over 70°F(21°C)) will attack FKM.	350°F 177°C	-40°F -40°C
Hytrel®: Good on acids, bases, amines and glycols at room temperatures only.	220°F 104°C	-20°F -29°C
Neoprene: All purpose. Resistance to vegetable oils. Generally not affected by moderate chemicals, fats, greases and many oils and solvents. Generally attacked by strong oxidizing acids, ketones, esters and nitro hydrocarbons and chlorinated aromatic hydrocarbons.	200°F 93°C	-10°F -23°C
Nitrile: General purpose, oil-resistant. Shows good solvent, oil, water and hydraulic fluid resistance. Should not be used with highly polar solvents like acetone and MEK, ozone, chlorinated hydrocarbons and nitro hydrocarbons.	190°F 88°C	-10°F -23°C
Nylon: 6/6 High strength and toughness over a wide temperature range. Moderate to good resistance to fuels, oils and chemicals.	180°F 82°C	32°F 0°C

Ambient temperature range: -20°C to +40°C

Process temperature range: -20°C to +80°C for models rated as category 1 equipment
-20°C to +100°C for models rated as category 2 equipment

In addition, the ambient temperature range and the process temperature range do not exceed the operating temperature range of the applied non-metallic parts as listed in the manuals of the pumps.

Polypropylene: A thermoplastic polymer. Moderate tensile and flex strength. Resists strong acids and alkali. Attacked by chlorine, fuming nitric acid and other strong oxidizing agents.	180°F 82°C	32°F 0°C
PVDF: (Polyvinylidene Fluoride) A durable fluoroplastic with excellent chemical resistance. Excellent for UV applications. High tensile strength and impact resistance.	250°F 121°C	0°F -18°C
Santoprene®: Injection molded thermoplastic elastomer with no fabric layer. Long mechanical flex life. Excellent abrasion resistance.	275°F 135°C	-40°F -40°C
UHMW PE: A thermoplastic that is highly resistant to a broad range of chemicals. Exhibits outstanding abrasion and impact resistance, along with environmental stress-cracking resistance.	180°F 82°C	-35°F -37°C
Urethane: Shows good resistance to abrasives. Has poor resistance to most solvents and oils.	150°F 66°C	32°F 0°C
Virgin PTFE: (PFA/TFE) Chemically inert, virtually impervious. Very few chemicals are known to chemically react with PTFE; molten alkali metals, turbulent liquid or gaseous fluorine and a few fluoro-chemicals such as chlorine trifluoride or oxygen difluoride which readily liberate free fluorine at elevated temperatures.	220°F 104°C	-35°F -37°C
<i>Maximum and Minimum Temperatures are the limits for which these materials can be operated. Temperatures coupled with pressure affect the longevity of diaphragm pump components. Maximum life should not be expected at the extreme limits of the temperature ranges.</i>		
Metals:		
Alloy C: Equal to ASTM494 CW-12M-1 specification for nickel and nickel alloy.		
Stainless Steel: Equal to or exceeding ASTM specification A743 CF-8M for corrosion resistant iron chromium, iron chromium nickel and nickel based alloy castings for general applications. Commonly referred to as 316 Stainless Steel in the pump industry.		

For specific applications, always consult the Chemical Resistance Chart.

SERVICE AND OPERATING INSTRUCTIONS

This Warren Rupp Tranquilizer® is a completely automatic diaphragm fitted surge suppressor to reduce the flow and pressure pulsations in a pumping system characteristic of reciprocating type pumps.

Principle of Operation: The Tranquilizer uses a flexible diaphragm to separate a liquid chamber from compressed air chambers. A rod connected to the center of one diaphragm activates the air inlet and exhaust valves, which automatically admit or exhaust air in the air chambers. This maintains the diaphragms in mid-range of stroke for maximum surge suppression.

Installation: Locate the Tranquilizer in discharge piping as close as possible to the pump. The unit will operate in any position. Connect air inlet connection to full plant air supply line before the air regulator to pump. Not to exceed 125PSI.

Service Instructions: When service is required, it is important to MAKE CERTAIN THAT INLET AIR PRESSURE IS DISCONNECTED. The diaphragms are serviced by simply removing the hex nuts or v-band, and removing the center spool casting. When Virgin PTFE diaphragms are used in conjunction with the elastomeric diaphragms they are placed over the “wetted” sides of each elastomeric diaphragm. Inlet and exhaust air valves are located externally for easy access and service.

Warranty: This unit is guaranteed for a period of five years against defective material and workmanship.

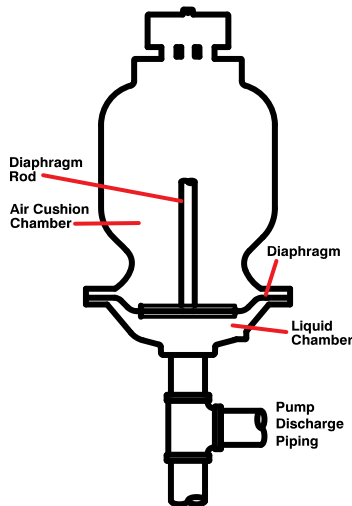

IMPORTANT



Read these safety warnings and instructions in this manual completely, before installation and start-up of the pulsation dampener. It is the responsibility of the purchaser to retain this manual for reference. Failure to comply with the recommendations stated in this manual will damage the pulsation dampener, and void factory warranty.

CAUTION



Before surge suppressor operation, inspect all gasketed fasteners for looseness caused by gasket creep. Re-torque loose fasteners to prevent leakage. Follow recommended torques stated in this manual.

WARNING



Before doing any maintenance on the pulsation dampener, be certain all pressure is completely vented from the pump, suction, discharge, piping, and all other openings and connections. Be certain the air supply is locked out or made non-operational, so that it cannot be started while work is being done on the pump. Be certain that approved eye protection and protective clothing are worn all times in the vicinity of the pump. Failure to follow these recommendations may result in serious injury or death.

WARNING



Take action to prevent static sparking. Fire or explosion can result, especially when handling flammable liquids. The pump, piping, valves, containers or other miscellaneous equipment must be grounded. See page 8.

HAZARD WARNING

POSSIBLE EXPLOSION HAZARD can result if 1, 1, 1, -Trichloroethane, Methylene Chloride or other Halogenated Hydrocarbon solvents are used in pressurized fluid systems having Aluminum or Galvanized wetted parts. Death, serious bodily injury and/or property damage could result. Consult with the factory if you have questions concerning Halogenated Hydrocarbon solvents.

Recommended Installation Guide

Available Accessories:

1. Surge Suppressor
2. Filter/Regulator
3. Air Dryer

Note: Surge Suppressor and Piping must be supported after the flexible connection

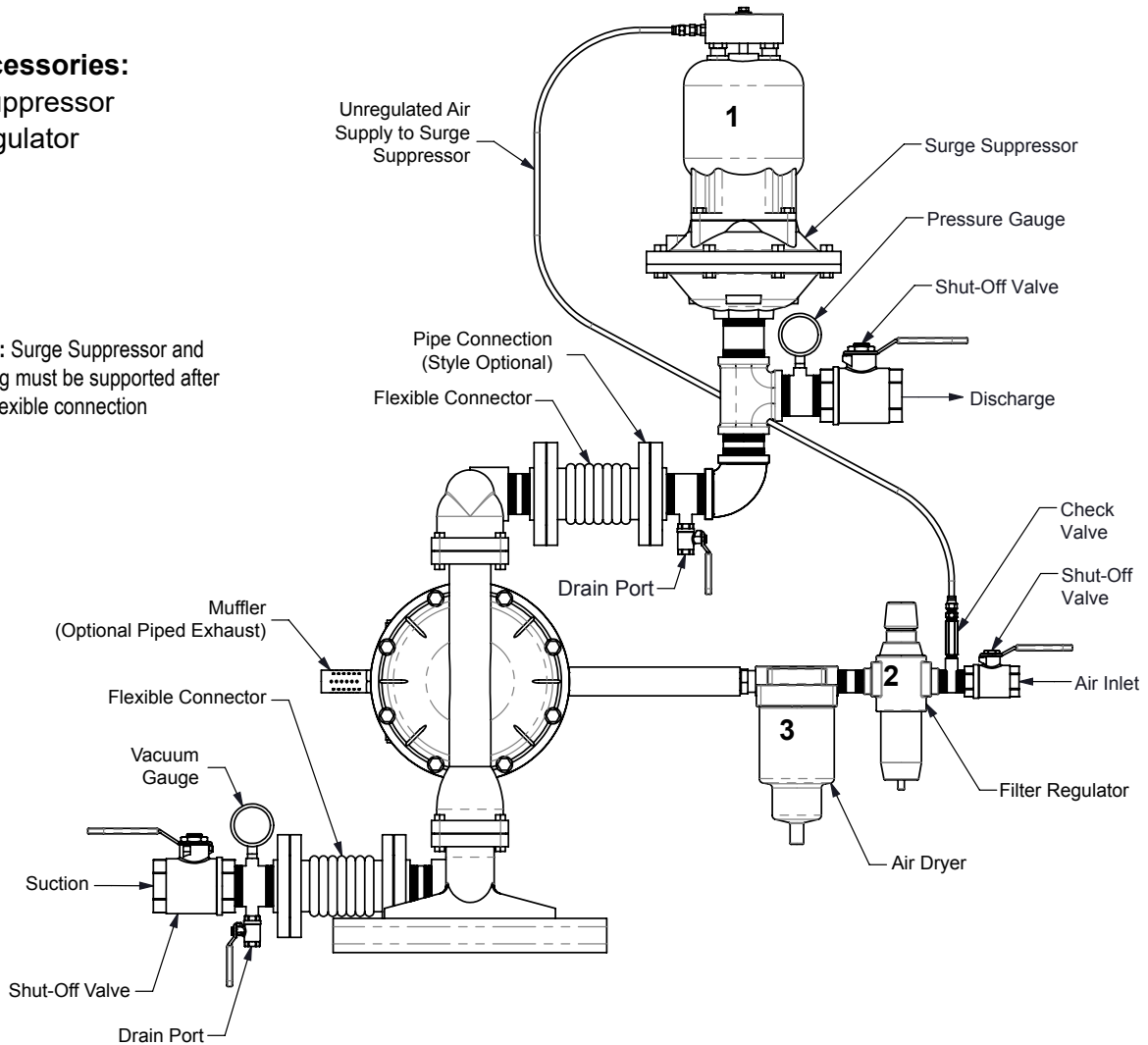

Installation And Start-Up

Locate the pump as close to the product being pumped as possible. Keep the suction line length and number of fittings to a minimum. Do not reduce the suction line diameter.

Air Supply

Connect the pump air inlet to an air supply with sufficient capacity and pressure to achieve desired performance. A pressure regulating valve should be installed to insure air supply pressure does not exceed recommended limits.

Air Valve Lubrication

The air distribution system is designed to operate **WITHOUT** lubrication. This is the standard mode of operation. If lubrication is desired, install an air line lubricator set to deliver one drop of SAE 10 non-detergent oil for every 20 SCFM (9.4 liters/sec.) of air the pump consumes. Consult the Performance Curve to determine air consumption.

Air Line Moisture

Water in the compressed air supply may cause icing or freezing of the exhaust air, causing the pump to cycle erratically or stop operating. Water in the air supply can be reduced by using a point-of-use air dryer.

Air Inlet And Priming

To start the pump, slightly open the air shut-off valve. After the pump primes, the air valve can be opened to increase air flow as desired. If opening the valve increases cycling rate, but does not increase the rate of flow, cavitation has occurred. The valve should be closed slightly to obtain the most efficient air flow to pump flow ratio.

Troubleshooting Guide

Symptom:	Potential Cause(s):	Recommendation(s):
Pump Cycles Once	Deadhead (system pressure meets or exceeds air supply pressure).	Increase the inlet air pressure to the pump. Pump is designed for 1:1 pressure ratio at zero flow. (Does not apply to high pressure 2:1 units).
	Air valve or intermediate gaskets installed incorrectly.	Install gaskets with holes properly aligned.
	Bent or missing actuator plunger.	Remove pilot valve and inspect actuator plungers.
Pump Will Not Operate / Cycle	Pump is over lubricated.	Set lubricator on lowest possible setting or remove. Units are designed for lube free operation.
	Lack of air (line size, PSI, CFM).	Check the air line size and length, compressor capacity (HP vs. cfm required).
	Check air distribution system.	Disassemble and inspect main air distribution valve, pilot valve and pilot valve actuators.
	Discharge line is blocked or clogged manifolds.	Check for inadvertently closed discharge line valves. Clean discharge manifolds/piping.
	Deadhead (system pressure meets or exceeds air supply pressure).	Increase the inlet air pressure to the pump. Pump is designed for 1:1 pressure ratio at zero flow. (Does not apply to high pressure 2:1 units).
	Blocked air exhaust muffler.	Remove muffler screen, clean or de-ice, and re-install.
	Pumped fluid in air exhaust muffler.	Disassemble pump chambers. Inspect for diaphragm rupture or loose diaphragm plate assembly.
	Pump chamber is blocked.	Disassemble and inspect wetted chambers. Remove or flush any obstructions.
Pump Cycles and Will Not Prime or No Flow	Cavitation on suction side.	Check suction condition (move pump closer to product).
	Check valve obstructed. Valve ball(s) not seating properly or sticking.	Disassemble the wet end of the pump and manually dislodge obstruction in the check valve pocket. Clean out around valve ball cage and valve seat area. Replace valve ball or valve seat if damaged. Use heavier valve ball material.
	Valve ball(s) missing (pushed into chamber or manifold).	Worn valve ball or valve seat. Worn fingers in valve ball cage (replace part). Check Chemical Resistance Guide for compatibility.
	Valve ball(s) / seat(s) damaged or attacked by product.	Check Chemical Resistance Guide for compatibility.
	Check valve and/or seat is worn or needs adjusting.	Inspect check valves and seats for wear and proper setting. Replace if necessary.
	Suction line is blocked.	Remove or flush obstruction. Check and clear all suction screens or strainers.
	Excessive suction lift.	For lifts exceeding 20' of liquid, filling the chambers with liquid will prime the pump in most cases.
	Suction side air leakage or air in product.	Visually inspect all suction-side gaskets and pipe connections.
Pump Cycles Running Sluggish / Stalling, Flow Unsatisfactory	Pumped fluid in air exhaust muffler.	Disassemble pump chambers. Inspect for diaphragm rupture or loose diaphragm plate assembly.
	Over lubrication.	Set lubricator on lowest possible setting or remove. Units are designed for lube free operation.
	Icing.	Remove muffler screen, de-ice, and re-install. Install a point of use air drier.
	Clogged manifolds.	Clean manifolds to allow proper air flow.
	Deadhead (system pressure meets or exceeds air supply pressure).	Increase the inlet air pressure to the pump. Pump is designed for 1:1 pressure ratio at zero flow. (Does not apply to high pressure 2:1 units).
	Cavitation on suction side.	Check suction (move pump closer to product).
	Lack of air (line size, PSI, CFM).	Check the air line size, length, compressor capacity.
	Excessive suction lift.	For lifts exceeding 20' of liquid, filling the chambers with liquid will prime the pump in most cases.
	Air supply pressure or volume exceeds system hd.	Decrease inlet air (press. and vol.) to the pump. Pump is cavitating the fluid by fast cycling.
	Undersized suction line.	Meet or exceed pump connections.
	Restrictive or undersized air line.	Install a larger air line and connection.
	Suction side air leakage or air in product.	Visually inspect all suction-side gaskets and pipe connections.
	Suction line is blocked.	Remove or flush obstruction. Check and clear all suction screens or strainers.
	Pumped fluid in air exhaust muffler.	Disassemble pump chambers. Inspect for diaphragm rupture or loose diaphragm plate assembly.
	Check valve obstructed.	Disassemble the wet end of the pump and manually dislodge obstruction in the check valve pocket.
Check valve and/or seat is worn or needs adjusting.	Inspect check valves and seats for wear and proper setting. Replace if necessary.	
Product Leaking Through Exhaust	Entrained air or vapor lock in chamber(s).	Purge chambers through tapped chamber vent plugs. Purging the chambers of air can be dangerous.
	Diaphragm failure, or diaphragm plates loose.	Replace diaphragms, check for damage and ensure diaphragm plates are tight.
Premature Diaphragm Failure	Diaphragm stretched around center hole or bolt holes.	Check for excessive inlet pressure or air pressure. Consult Chemical Resistance Chart for compatibility with products, cleaners, temperature limitations and lubrication.
	Cavitation.	Enlarge pipe diameter on suction side of pump.
	Excessive flooded suction pressure.	Move pump closer to product. Raise pump/place pump on top of tank to reduce inlet pressure. Install Back pressure device (Tech bulletin 41r). Add accumulation tank or pulsation dampener.
	Misapplication (chemical/physical incompatibility).	Consult Chemical Resistance Chart for compatibility with products, cleaners, temperature limitations and lubrication.
Unbalanced Cycling	Incorrect diaphragm plates or plates on backwards, installed incorrectly or worn.	Check Operating Manual to check for correct part and installation. Ensure outer plates have not been worn to a sharp edge.
	Excessive suction lift.	For lifts exceeding 20' of liquid, filling the chambers with liquid will prime the pump in most cases.
	Undersized suction line.	Meet or exceed pump connections.
	Pumped fluid in air exhaust muffler.	Disassemble pump chambers. Inspect for diaphragm rupture or loose diaphragm plate assembly.
	Suction side air leakage or air in product.	Visually inspect all suction-side gaskets and pipe connections.
	Check valve obstructed.	Disassemble the wet end of the pump and manually dislodge obstruction in the check valve pocket.
	Check valve and/or seat is worn or needs adjusting.	Inspect check valves and seats for wear and proper setting. Replace if necessary.
Entrained air or vapor lock in chamber(s).	Purge chambers through tapped chamber vent plugs.	

For additional troubleshooting tips contact After Sales Support at service.warrenrupp@idexcorp.com or 419-524-8388

Composite Repair Parts Drawing

3: EXP VIEW

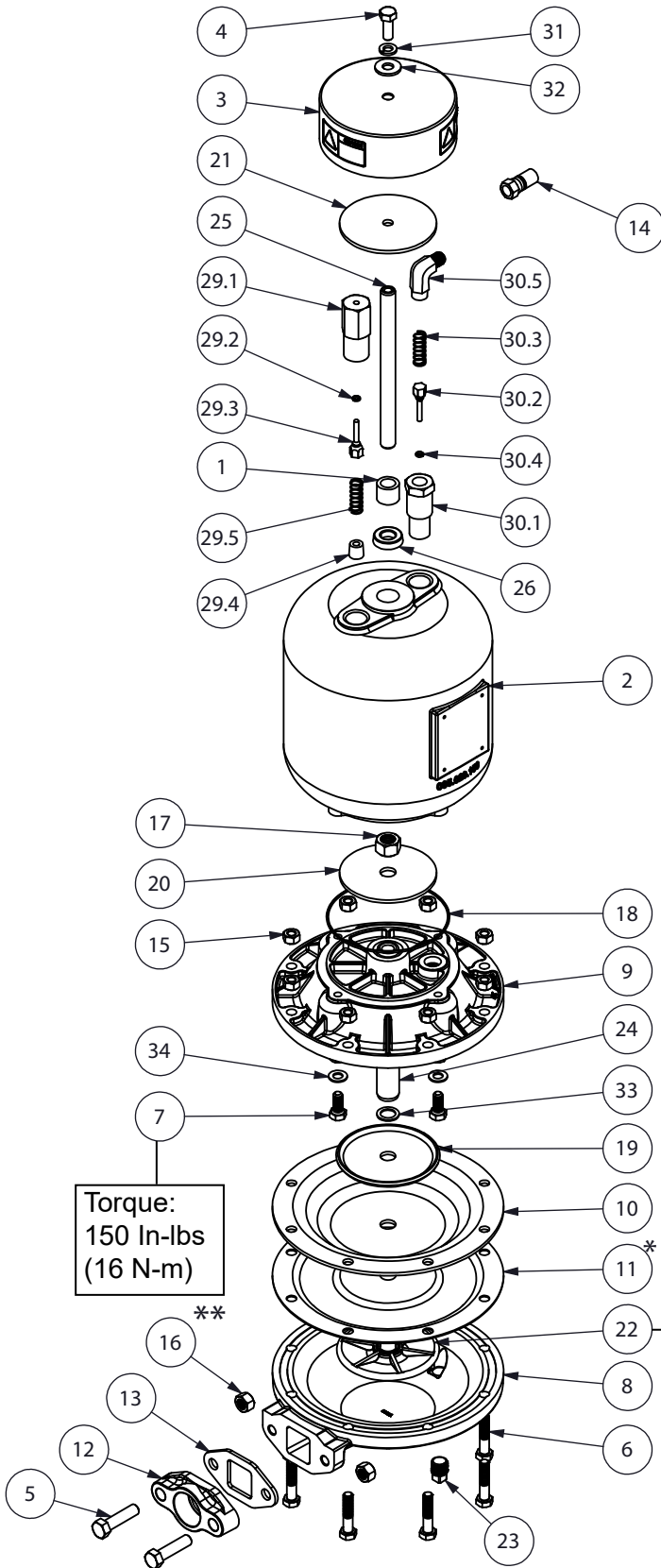

Torque:
150 In-lbs
(16 N-m)

Torque:
350 In-lbs (38 N-m) elastomeric fitted
450 In-lbs (50 N-m) PTFE fitted

* Used only on PTFE fitted units
** Used only on Stainless Steel fitted units

Composite Repair Parts List

ITEM NO.	PART NUMBER	DESCRIPTION	QTY.
1	070.014.170	Bearing, Sleeve	1
2	095.029.156	Body	1
3	165.023.000	Cap	1
4	170.005.330	Capscrew, Hex Hd 5/16-18 X 7/8	1
5	170.009.330	Capscrew, Hex Hd 3/8-16 x 1 1/2	2
6	170.029.330	Capscrew, Hex Hd 5/16-18 x 1 1/2	8
7	170.057.330	Capscrew, Hx Hd 5/16-18 x 3/4	4
8	196.012.110	Outer Chamber (Stainless Units)	1
	196.012.157	Outer Chamber	1
9	196.018.157	Chamber	1
10	286.008.354	Diaphragm	1
	286.008.356	Diaphragm	1
	286.008.360	Diaphragm	1
	286.008.363	Diaphragm	1
	286.008.364	Diaphragm	1
	286.008.365	Diaphragm	1
	286.008.366	Diaphragm	1
11	286.015.604	Diaphragm, Overlay	1
12	334.018.110E	Flange, Threaded (1" BSP Tapered)	1
	334.018.156E	Flange, Threaded (1" BSP Tapered)	1
13	360.030.425	Gasket, Flange	1
	360.030.600	Gasket, Flange (PTFE and FKM Units)	1
14	866.078.330	Tube Fitting	1
15	545.004.330	Nut, Hex 5/16-18	8
16	545.005.330	Nut, Hex 3/8-16 (Stainless Units)	2
17	545.008.330	Nut, Hex 1/2-13	1
18	560.040.360	O-Ring	1
19	612.022.330	Plate, Inner Diaphragm	1
20	612.043.330	Plate, Activator	1
21	612.044.330	Plate, Activator	1
22	612.101.110	Plate, Outer Diaphragm	1
	612.108.157	Plate, Outer Diaphragm	1
23	618.003.110	Plug, 1/4 Pipe (Stainless Units)	1
	618.003.330	Plug, 1/4 Pipe	1
24	685.027.120	Rod, Diaphragm	1
25	685.028.120	Rod, Activator	1
26	720.012.360	Seal, Shaft	1
29	893.021.000	Valve Assembly	1
29.1	095.020.162	Body, Valve	1
29.2	560.001.360	O-Ring	1
29.3	622.002.162	Poppet	1
29.4	670.007.162	Spring, Retainer	1
29.5	780.013.115	Spring, Compression	1
30	893.023.000	Valve Assembly	1
30.1	095.019.162	Body, Valve	1
30.2	622.002.162	Poppet	1
30.3	780.013.115	Spring, Compression	1
30.4	560.001.360	O-Ring	1
30.5	866.010.162	Elbow, Male	1
31	900.004.330	Washer, Lock 5/16	1
32	901.009.115	Washer, Flat 5/16	1
33	901.012.180	Washer, Sealing	1
34	901.014.180	Washer, Sealing	4

Material Codes - The Last 3 Digits of Part Number

000.....Assembly, sub-assembly; and some purchased items	364.....EPDM Rubber Color coded: BLUE
010.....Cast Iron	365.....Neoprene Rubber Color coded: GREEN
015.....Ductile Iron	366.....Food Grade Nitrile
020.....Ferritic Malleable Iron	368.....Food Grade EPDM
080.....Carbon Steel, AISI B-1112	371.....Philthane (Tuftane)
110.....Alloy Type 316 Stainless Steel	374.....Carboxylated Nitrile
111.....Alloy Type 316 Stainless Steel (Electro Polished)	375.....Fluorinated Nitrile
112.....Alloy C	378.....High Density Polypropylene
113.....Alloy Type 316 Stainless Steel (Hand Polished)	379.....Conductive Nitrile
114.....303 Stainless Steel	408.....Cork and Neoprene
115.....302/304 Stainless Steel	425.....Compressed Fibre
117.....440-C Stainless Steel (Martensitic)	426.....Blue Gard
120.....416 Stainless Steel (Wrought Martensitic)	440.....Vegetable Fibre
148.....Hardcoat Anodized Aluminum	500.....Delrin® 500
150.....6061-T6 Aluminum	502.....Conductive Acetal, ESD-800
152.....2024-T4 Aluminum (2023-T351)	503.....Conductive Acetal, Glass-Filled
155.....356-T6 Aluminum	506.....Delrin® 150
156.....356-T6 Aluminum	520.....Injection Molded PVDF Natural color
157.....Die Cast Aluminum Alloy #380	540.....Nylon
158.....Aluminum Alloy SR-319	542.....Nylon
162.....Brass, Yellow, Screw Machine Stock	544.....Nylon Injection Molded
165.....Cast Bronze, 85-5-5-5	550.....Polyethylene
166.....Bronze, SAE 660	551.....Glass Filled Polypropylene
170.....Bronze, Bearing Type, Oil Impregnated	552.....Unfilled Polypropylene
180.....Copper Alloy	555.....Polyvinyl Chloride
305.....Carbon Steel, Black Epoxy Coated	556.....Black Vinyl
306.....Carbon Steel, Black PTFE Coated	558.....Conductive HDPE
307.....Aluminum, Black Epoxy Coated	570.....Rulon II®
308.....Stainless Steel, Black PTFE Coated	580.....Ryton®
309.....Aluminum, Black PTFE Coated	600.....PTFE (virgin material) Tetrafluorocarbon (TFE)
313.....Aluminum, White Epoxy Coated	603.....Blue Gylon®
330.....Zinc Plated Steel	604.....PTFE
332.....Aluminum, Electroless Nickel Plated	606.....PTFE
333.....Carbon Steel, Electroless Nickel Plated	607.....Envelon
335.....Galvanized Steel	608.....Conductive PTFE
337.....Silver Plated Steel	610.....PTFE Encapsulated Silicon
351.....Food Grade Santoprene®	611.....PTFE Encapsulated FKM
353.....Geolast; Color: Black	632.....Neoprene/Hytrel®
354.....Injection Molded #203-40 Santoprene® Duro 40D +/-5; Color: RED	633.....FKM/PTFE
356.....Hytrel®	634.....EPDM/PTFE
357.....Injection Molded Polyurethane	635.....Neoprene/PTFE
358.....Urethane Rubber (Some Applications) (Compression Mold)	637.....PTFE, FKM/PTFE
359.....Urethane Rubber	638.....PTFE, Hytrel®/PTFE
360.....Nitrile Rubber Color coded: RED	639.....Nitrile/TFE
363.....FKM (Fluorocarbon) Color coded: YELLOW	643.....Santoprene®/EPDM
	644.....Santoprene®/PTFE
	656.....Santoprene® Diaphragm and Check Balls/EPDM Seats
	661.....EPDM/Santoprene®
	666.....FDA Nitrile Diaphragm, PTFE Overlay, Balls, and Seals
	668.....PTFE, FDA Santoprene®/PTFE

- Delrin and Hytrel are registered tradenames of E.I. DuPont.
- Nylatron is a registered tradename of Polymer Corp.
- Gylon is a registered tradename of Garlock, Inc.
- Santoprene is a registered tradename of Exxon Mobil Corp.
- Rulon II is a registered tradename of Dixon Industries Corp.
- Ryton is a registered tradename of Phillips Chemical Co.
- Valox is a registered tradename of General Electric Co.

5 - YEAR Limited Product Warranty

Warren Rupp, Inc. ("Warren Rupp") warrants to the original end-use purchaser that no product sold by Warren Rupp that bears a Warren Rupp brand shall fail under normal use and service due to a defect in material or workmanship within five years from the date of shipment from Warren Rupp's factory. Warren Rupp brands include Warren Rupp®, SANDPIPER®, SANDPIPER Signature Series™, MARATHON®, Porta-Pump®, SludgeMaster™ and Tranquilizer®.

The use of non-OEM replacement parts will void (or negate) agency certifications, including CE, ATEX, CSA, 3A and EC1935 compliance (Food Contact Materials). Warren Rupp, Inc. cannot ensure nor warrant non-OEM parts to meet the stringent requirements of the certifying agencies.

~ See sandpiperpump.com/content/warranty-certifications for complete warranty, including terms and conditions, limitations and exclusions. ~

**WARREN
RUPP, INC.**

Declaration of Conformity

Manufacturer: Warren Rupp, Inc., 800 N. Main Street
Mansfield, Ohio, 44902 USA

Certifies that Air-Operated Double Diaphragm Pump Series: HDB, HDF, M Non-Metallic, S Non-Metallic, M Metallic, S Metallic, T Series, G Series, U Series, EH and SH High Pressure, RS Series, W Series, F Series, SMA and SPA Submersibles, and Tranquilizer® Surge Suppressors comply with the European Community Directive 2006/42/EC on Machinery, according to Annex VIII.

This product has used Harmonized Standard EN809:2012, Pumps and Pump Units for Liquids - Common Safety Requirements, to verify conformance.

Signature of authorized person

October 20, 2005
Date of issue

Authorised Representative:
IDEX Pump Technologies
R79 Shannon Industrial Estate
Shannon, Co. Clare, Ireland

Director of Engineering
Title

February 27, 2017
Date of revision

Attn: Barry McMahon

IDEX

Revision Level: F

CE

EU Declaration of Conformity

Manufacturer:

Warren Rupp, Inc.
A Unit of IDEX Corporation
800 North Main Street
Mansfield, OH 44902 USA

Warren Rupp, Inc. declares that Air Operated Double Diaphragm Pumps (AODD) and Surge Suppressors listed below comply with the requirements of **Directive 2014/34/EU** and all applicable standards.

Applicable Standards

- EN80079-36: 2016
- EN80079-37: 2016
- EN60079-25: 2010

1. AODD Pumps and Surge Suppressors - Technical File No.: 20310400-1410/MERHazardous Location Applied:

II 2 G Ex h IIC T5...225°C (T2) Gb
 II 2 D Ex h IIIC T100°C...T200°C Db
II 2 G Ex h IIB T5...225°C (T2) Gb
II 2 D Ex h IIIB T100°C...T200°C Db

- Metallic pump models with external aluminum components (S Series, HD Series, G Series, DMF Series, MSA Series, U Series, F Series, T Series)
- Conductive plastic pump models with integral muffler (S Series, PB Series)
- Tranquilizer[®] surge suppressors

2. AODD Pumps - EU Type Examination Certificate No.: DEKRA 18ATEX0094X - DEKRA Certification B.V. (0344)

Meander 1051
6825 MJ Arnhem
The Netherlands

Hazardous Location Applied:

I M1 Ex h I Ma
II 1 G Ex h IIC T5...225°C (T2) Ga
II 1 D Ex h IIIC T100°C...T200°C Da
 II 2 G Ex h ia IIC T5 Gb
II 2 D Ex h ia IIIC T100°C Db
II 2 G Ex h mb IIC T5 Gb
II 2 D Ex mb tb IIIC T100° Db

- Metallic pump models with no external aluminum (S series, HD Series, G series)
- Conductive plastic pumps equipped with metal muffler (S series, PB Series)
- ATEX pump models equipped with ATEX rated pulse output kit or solenoid kit

- See "ATEX Details" page in user's manual for more information
- See "Safety Information" page for conditions of safe use

DATE/APPROVAL/TITLE:
26 SEP 2018

David Roseberry, Director of Engineering

WARREN RUPP, INC.

Declaration of Conformity

Manufacturer: Warren Rupp, Inc., 800 N. Main Street, Mansfield, Ohio, 44902 USA

certifies that SANDPIPER® Air-Operated Double Diaphragm Food Processing Pump Models and Tranquilizer® Surge Suppressor Models comply with the European Community Regulations:

(EC) No 1935/2004 for Food Contact Materials

(EC) No 2023/2006 Good Manufacturing Practice

(EU) No 10/2011 on plastic materials and articles intended to come in contact with food

Food Processing Pump Models:

T1FB1SASWTS600.	T15B1SSTSTS600.	T30B1SDSWTS600.	F10B1SZSNTF600.	F20B1SKSNTF600.
T1FB1S9SWTS600.	T20B1SASWTS600.	T30B1SASSTS600.	F10B1SDSNTF600.	F20B1SZSNTF600.
T1FB1SDSWTS600.	T20B1SDSWTS600.	T30B1SDSSTS600.	F15B1SKTNTF600.	F20B1SDDNTF600.
T1FB1SLSWTS600.	T20B1SASSTS600.	SSB2, TD3SS.	F15B1SZSNTF600.	F20B1SHSNTC600.
T1FB1S9TWTWS600.	T20B1SDSSTS600.	F05B1SGSPTF000.	F15B1SHHNTF600.	F20B1SKSNTC600.
T15B1SDSWTS600.	T20B1SASWTS600.	F05B1SZSPTF000.	F15B1SDDNTF600.	F20B1SZSNTC600.
T15B1SSSWTS600.	T20B1SDSWTS600.	F05B1SHSPTF000.	F15B1SKSNTC600.	F30B1SHHNTF600.
T15B1SDSSTS600.	T20B1SASSTS600.	F05B1SDSPTF000.	F15B1SZSNTC600.	F30B1SDDNTF600.
T15B1SSSSTS600.	T20B1SDSSTS600.	F10B1SHSNTF600.	F15B1SHSNTC600.	F30B1SKSNTF600.
T15B1SSTWTS600.	T30B1SASWTS600.	F10B1SKSNTF600.	F20B1SHHNTF600.	F30B1SZSNTF600.

Tranquilizer® Surge Suppressors:

TA1,NG1SS	TA2,NG2SS
TA25,NG1SS	TA50,NG2SS
TA1-1/2,NG1SS	TA3,NG2SS
TA40,NG1SS	TA80,NG2SS

- Materials used in equipment intended for food contact (Annex I (EC) No 1935/2004) :
 - Rubber
 - Metals & Alloys
 - Plastics

Plastic Materials: PTFE and FKM/ PTFE coated

The plastic components are suitable to come in contact with multiple food types, provided that storage contact time does not exceed 1/2 hour, contact temperature does not exceed 40°C and maximum operating temperatures within the instructions manual are not exceeded. Diaphragm failure may allow process fluids to come in contact with nonconforming materials. Regular inspections are recommended.

- This Declaration is based on :
 - Declaration of Conformities from raw material suppliers
 - Total Migration Analysis per (EU) No 10/2011
- Supporting document will be made available to competent authorities to demonstrate compliance

David Roseberry
Signature of authorized person

David Roseberry
Printed name of authorized person

February 8, 2013
Date of issue

Director of Engineering
Title

February 25, 2019
Date of revision

