



SERVICE AND OPERATING MANUAL

Original Instructions

Model SA1

Model SA25

Type 4



See Explanation of
ATEX Certification Page



Table of Contents

Engineering Data, Temperature Limitations, & Performance Curve	1
Explanation of Pump Nomenclature	2
Dimensions	3
Principle of Operation	4
Installation and Start-Up	4
Chamber Porting	4
Air Supply	5
Air Inlet & Priming	5
Air Exhaust	5
Between Uses	5
Check Valve Servicing	5
Diaphragm Servicing	5
Air Valve Lubrication	6
ESADS+Plus®: Externally Serviceable Air Distribution System	6
Pilot Valve	7
Pilot Valve Actuator	7
Service Instructions: Troubleshooting	7
Warranty	8
Recommended Accessories	8
Important Safety Information	9
Recycling	9
Grounding The Pump	10
Material Codes	11
Composite Repair Parts List	12-13
Composite Repair Drawing	14
CE Declaration of Conformity - Machinery	15
CE Declaration fo Conformity - ATEX	16
Explanation of ATEX Certification	17

Warren Rupp, Inc. • A Unit of IDEX Corporation • 800 N. Main St., Mansfield, Ohio 44902 USA
Telephone (419) 524-8388 • Fax (419) 522-7867 • www.warrenrupp.com

**WARREN
RUPP, INC.®**

Quality System
ISO9001 Certified

Environmental
Management System
ISO14001 Certified

IPX
FLUID & METERING



Ex See Explanation of
ATEX Certification Page



SANDPIPER®
A WARREN RUPP, INC. BRAND

**FLAP-VALVE
SA1 Type 4
SA25 Type 4**

**Air-Operated
Double Diaphragm Pump**

ENGINEERING, PERFORMANCE
& CONSTRUCTION DATA

INTAKE/DISCHARGE PIPE SIZE	CAPACITY	AIR VALVE	SOLIDS-HANDLING	HEADS UP TO
SA1: 1" NPT SA25: 1" BSP Tapered	0 to 42 gallons per minute (0 to 159 liters per minute)	No lube, no-stall design.	Up to nearly 1" (25mm)	125 psi or 289 ft. of water (8.8 Kg/cm ² or 88 meters)

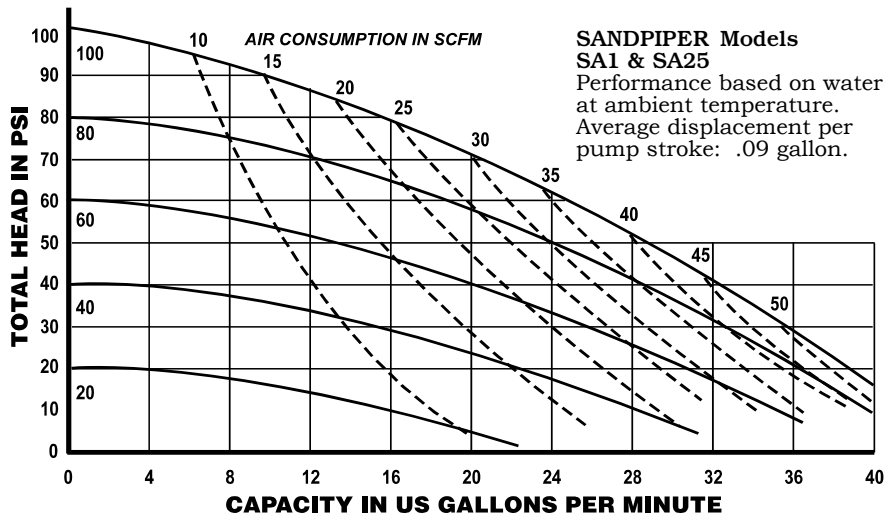
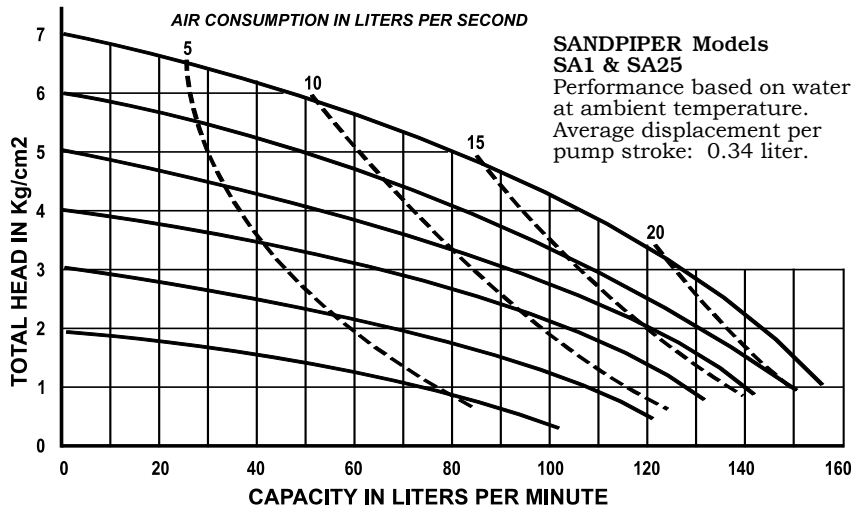

MATERIALS OF CONSTRUCTION

To order a pump or replacement parts, first enter the Model Number SA1, or SA25, followed by the Type Designation listed below in the far left column.

Type	Manifold Porting			Manifold	Outer Chamber	Inner Chamber	Outer Diaphragm Plate	Inner Diaphragm Plate	Intermediate Housing	Diaphragm Rod	Valve Seat	Hard-ware	Diaphragm	Flap Valve Material	Seat/ Manifold Gasket	Air Valve	Air Valve Cap	Shipping Wt. (lbs)
	Top	Side	Bottom															
DB-4-A			X	356-T6AL	AL380DC	AL380DC	AL380DC	PS	AL380DC	416SS	SS	PS	B	B	B	PE	AL380DC	31
DI-4-A			X	356-T6AL	AL380DC	AL380DC	AL380DC	PS	AL380DC	416SS	SS	PS	I	I	I	PE	AL380DC	31
DN-4-A			X	356-T6AL	AL380DC	AL380DC	AL380DC	PS	AL380DC	416SS	SS	PS	N	N	N	PE	AL380DC	31
DV-4-A			X	356-T6AL	AL380DC	AL380DC	AL380DC	PS	AL380DC	416SS	SS	PS	V	V	V	PE	AL380DC	31
TB-4-A	X			356-T6AL	AL380DC	AL380DC	AL380DC	PS	AL380DC	416SS	SS	PS	B	B	B	PE	AL380DC	31
TI-4-A	X			356-T6AL	AL380DC	AL380DC	AL380DC	PS	AL380DC	416SS	SS	PS	I	I	I	PE	AL380DC	31
TN-4-A	X			356-T6AL	AL380DC	AL380DC	AL380DC	PS	AL380DC	416SS	SS	PS	N	N	N	PE	AL380DC	31
TV-4-A	X			356-T6AL	AL380DC	AL380DC	AL380DC	PS	AL380DC	416SS	SS	PS	V	V	V	PE	AL380DC	31
DB-4-SS			X	SS	SS	AL380DC	SS	PS	AL380DC	416SS	SS	PS*	B	B	B	PE	AL380DC	48
DI-4-SS			X	SS	SS	AL380DC	SS	PS	AL380DC	416SS	SS	PS*	I	I	I	PE	AL380DC	48
DN-4-SS			X	SS	SS	AL380DC	SS	PS	AL380DC	416SS	SS	PS*	N	N	N	PE	AL380DC	48
DV-4-SS			X	SS	SS	AL380DC	SS	PS	AL380DC	416SS	SS	PS*	V	V	V	PE	AL380DC	48
TB-4-SS	X			SS	SS	AL380DC	SS	PS	AL380DC	416SS	SS	PS*	B	B	B	PE	AL380DC	48
TI-4-SS	X			SS	SS	AL380DC	SS	PS	AL380DC	416SS	SS	PS*	I	I	I	PE	AL380DC	48
TN-4-SS	X			SS	SS	AL380DC	SS	PS	AL380DC	416SS	SS	PS*	N	N	N	PE	AL380DC	48
TV-4-SS	X			SS	SS	AL380DC	SS	PS	AL380DC	416SS	SS	PS*	V	V	V	PE	AL380DC	48
DB-4-SI			X	SS	SS	CI	SS	PS	CI	416SS	SS	PS*	B	B	B	PE	PE	63
DI-4-SI			X	SS	SS	CI	SS	PS	CI	416SS	SS	PS*	I	I	I	PE	PE	63
DN-4-SI			X	SS	SS	CI	SS	PS	CI	416SS	SS	PS*	N	N	N	PE	PE	63
DV-4-SI			X	SS	SS	CI	SS	PS	CI	416SS	SS	PS*	V	V	V	PE	PE	63
TB-4-SI	X			SS	SS	CI	SS	PS	CI	416SS	SS	PS*	B	B	B	PE	PE	63
TI-4-SI	X			SS	SS	CI	SS	PS	CI	416SS	SS	PS*	I	I	I	PE	PE	63
TN-4-SI	X			SS	SS	CI	SS	PS	CI	416SS	SS	PS*	N	N	N	PE	PE	63
TV-4-SI	X			SS	SS	CI	SS	PS	CI	416SS	SS	PS*	V	V	V	PE	PE	63

Note: For dual-ported unit, add "E" to pump type prefix. (For example: EDB-4-A).

Meanings of Abbreviations:

AL = Aluminum DC = Die Cast PE = Conductive HDPE PS* = Plated Steel, except T = PTFE
 B = Nitrile I = EPDM PS = Plated Steel wetted area which is 316SS V = FKM
 CI = Cast Iron N = Neoprene SS = Stainless Steel

MATERIALS

Operating Temperature

Maximum* Minimum*

NITRILE General purpose, oil-resistant. Shows good solvent, oil, water and hydraulic fluid resistance. Should not be used with highly polar solvents like acetone and MEK, ozone, chlorinated hydrocarbons and nitro hydrocarbons.

190°F
88°C -10°F
-23°C

NEOPRENE All purpose. Resistant to vegetable oils. Generally not affected by moderate chemicals, fats, greases and many oils and solvents. Generally attacked by strong oxidizing acids, ketones, esters, nitro hydrocarbons and chlorinated aromatic hydrocarbons.

170°F
77°C -35°F
-37°C

FKM (Fluorocarbon) Shows good resistance to a wide range of oils and solvents; especially all aliphatic, aromatic and halogenated hydrocarbons, acids, animal and vegetable oils. Hot water or hot aqueous solutions (over 70° F) will attack FKM.

212°F+
100°C+ +32°F
0°C

EPDM Shows very good water and chemical resistance. Has poor resistance to oil and solvents, but is fair in ketones and alcohols.

212°F+
100°C+ -10°F
-23°C

STAINLESS STEEL CF-8M equal to or exceeding ASTM specification A743 for corrosion resistant iron chromium, iron chromium nickel, and nickel based alloy castings for general applications. Commonly referred to as 316 Stainless Steel in the pump industry.

For specific applications, always consult The Warren Rupp Chemical Resistance Chart.

*Definite reduction in service life.
 **Minimal reduction in service life at ends of range.



II 1 G c T5
 II 3/1 G c T5
 II 1 D c T100oC

I M1 c
 I M2 c
 Models equipped with Stainless Steel or Alloy
 C wetted parts, and Cast Iron midsection parts.
 See Explanation of ATEX Certification.



II 2 G c T5
 II 3/2 G c T5
 II 2 D c T100oC

All models, including pumps equipped with
 Aluminum wetted and midsection parts.
 See See Explanation of ATEX Certification.

Maximum and Minimum
 Temperatures are the limits for
 which these materials can be
 operated. Temperatures coupled
 with pressure affect the longevity
 of diaphragm pump components.
 Maximum life should not be
 expected at the extreme limits of
 the temperature ranges.

SA1 & SA25

FLAP-VALVE



Dimensions are $\pm 1/8"$
 Figures in parenthesis = millimeters

**Model SA1 features
 NPT threaded connections.**
**Model SA25 features
 British Standard Pipe
 (BSP) Tapered threaded
 connections.**

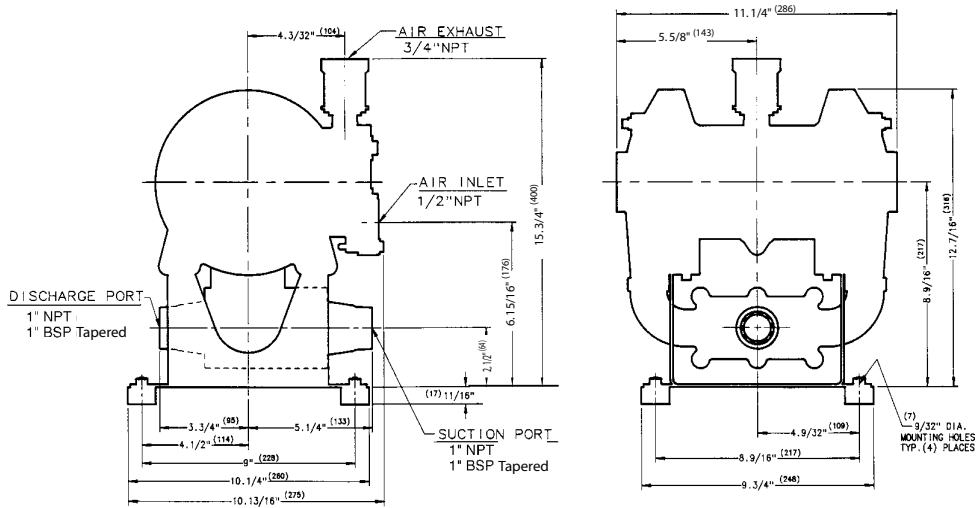
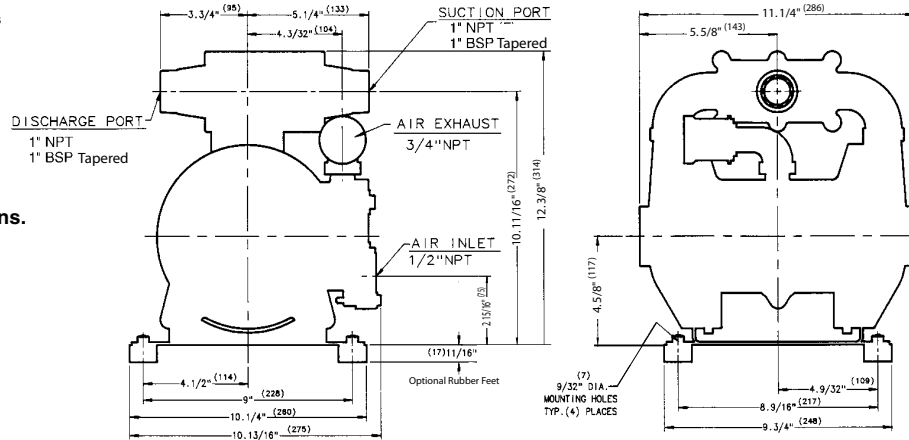



SERVICE AND OPERATING MANUAL

Model SA1
Model SA25
Type 4

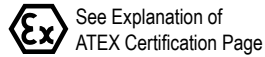

PLEASE NOTE!

The photos shown in this manual are for general instruction only. Your specific model may not be shown. Always refer to the parts list and exploded view drawing for your specific model when installing, disassembling or servicing your pump.

PRINCIPLE OF PUMP OPERATION

This flap swing check valve pump is powered by compressed air and is a 1:1 pressure ratio design. It alternately pressurizes the inner side of one diaphragm chamber, while simultaneously exhausting the other inner chamber. This causes the diaphragms, which are connected by a common rod, to move endwise. Air pressure is applied over the entire surface of the diaphragm, while liquid is discharged from the opposite side. The diaphragm operates under a balanced condition during the discharge stroke, which allows the unit to be operated at discharge heads over 200 feet (61 meters) of water head.

Since the diaphragms are connected by a common rod, secured by plates to the center of the diaphragms, one diaphragm performs the discharge stroke, while the other is pulled to perform the suction stroke in the opposite chamber.

For maximum diaphragm life, keep the pump as close to the liquid being pumped as possible. Positive suction head in excess of 10 feet of liquid (3.048 meters) may require a back pressure regulating device. This will maximize diaphragm life.

Alternate pressuring and exhausting of the diaphragm chamber is performed by means of an externally mounted, pilot operated, four-way spool type air distribution valve. When the spool shifts to one end of the valve body, inlet air pressure is applied to one diaphragm chamber and the other diaphragm chamber exhausts. When the spool shifts to the opposite end of the valve body, the porting of chambers is reversed. The air distribution valve spool is moved by an internal pilot valve which alternately pressurizes one side of the air distribution valve spool, while exhausting the other side. The pilot valve is shifted at each end of the diaphragm stroke by the diaphragm plate coming in contact with the end of the pilot valve spool. This pushes it into position for shifting of the air distribution valve.

The chambers are manifolded together with a suction and discharge check valve for each chamber, maintaining flow in one direction through the pump.

INSTALLATION & START-UP

Locate the pump as close to the product being pumped as possible, keeping suction line length and number of fittings to a minimum. Do not reduce line size.

For installations of rigid piping, short flexible sections of hose should be installed between pump and piping. This reduces vibration and strain to the piping system. A Warren Rupp Tranquilizer® surge suppressor is recommended to further reduce pulsation in flow.

This pump was tested at the factory prior to shipment and is ready for operation. It is completely self-priming from a dry start for suction lifts of 5-7 feet (1.5-2 meters) or less. For suction lifts exceeding 10 feet of liquid, fill the chambers with liquid prior to priming.

CHAMBER PORTING

SA1 with bottom chamber porting of check valve manifolding is recommended for general portable pumping applications, low head transfer pumping, and for pumping solids-laden liquids which tend to settle out.

For low flow, high pressure applications and for pumping highly viscous liquids, top porting of chamber to check valve manifold is recommended. Model SA1 SANDPIPER with flap type valves can be arranged in either bottom chamber porting or top chamber porting of check valve manifold simply by rotating outer diaphragm chambers 180° and reversing the flap valves and seats in the manifold so they remain in the proper operating position—hanging downward. Make certain that the flap valves are opening outward from the manifold.

Note: Low profile mounting feet are available when the top porting configuration is used.

AIR SUPPLY

Air supply pressures cannot exceed 125 psi (8.61 bar). Connect the pump air inlet to an air supply of sufficient capacity and pressure required for desired performance. When the air line is solid piping, use a short length of flexible hose (not less than 3/4" (19mm) in diameter) between pump and piping to eliminate strain to pipes. Use of a Warren Rupp Filter/Regulator in the air line is recommended.

AIR INLET & PRIMING

For start-up, open an air valve approximately 1/4" to 1/2" turn. After the unit primes, an air valve can be opened to increase flow as desired. If opening the valve increases cycling rate, but does not increase flow rate, cavitation has occurred, and the valve should be closed slightly.

For the most efficient use of compressed air and the longest diaphragm life, throttle the air inlet to the lowest cycling rate that does not reduce flow.

AIR EXHAUST

If a diaphragm fails, the pumped liquid or fumes can enter the air end of the pump, and be exhausted into the atmosphere. When pumping hazardous or toxic materials, pipe the exhaust to an appropriate area for safe disposition.

This pump can be submerged if materials of construction are compatible with the liquid. The air exhaust must be piped above the liquid level. Piping used for the air exhaust must not be smaller than 1" (2.54 cm). Reducing the pipe size will restrict air flow and reduce pump performance. When the product source is at a higher level than the pump (flooded suction), pipe the exhaust higher than the product source to prevent siphoning spills.

Freezing or icing of the air exhaust can occur under certain temperature and humidity conditions. Use of an air dryer should eliminate most icing problems.

BETWEEN USES

When used for materials that tend to settle out or transform to solid form, the pump should be completely flushed after each use, to prevent damage. Product remaining in the pump between uses could dry out or settle out. This could cause problems with valves and diaphragms at re-start. In freezing temperatures, the pump must be drained between uses in all cases.

CHECK VALVE SERVICING

Need for inspection or service is usually indicated by poor priming, unstable cycling, reduced performance or the pump's cycling but not pumping.

Remove the six flange bolts securing the inlet and outlet flanges to the manifold. Inspect the surfaces of both check valve and seat for wear or damage that could prevent proper sealing. If pump is to prime properly, valves must seat air tight.

Flap type models can be assembled with the manifold positioned under the diaphragm chamber (bottom porting) or above (top porting). Inlet and outlet flange pipe threads run horizontal in either case. Flap valves and seats must be reassembled to unit to conform to the "IN" and "OUT" markings on the base plate. Install the valve seat and flap valve on the side of the unit marked "OUT" with the flap valve hanging down and swinging away from the manifold into the flange. Install the flap valve and seat on the other side of the unit marked "IN" with the flap valve hanging down and swinging into the manifold, away from the flange. Inlet and outlet direction is determined by how the check valves are installed.

DIAPHRAGM SERVICING

Remove the four bolts securing the manifold flange to the chamber. Remove the eight nuts securing the outer diaphragm chamber flange and remove the chamber. Loosen the capscrew securing the diaphragm and plate to the rod by leaving the diaphragm engaged with the capscrews around the outer flange, preventing rotation of the rod. **DO NOT USE A WRENCH ON THE DIAPHRAGM ROD. FLAWS ON THE SURFACE MAY DAMAGE BEARINGS AND SEAL.**

During reassembly make certain that the rubber bumper is on the rod on each side. Install the diaphragm with the natural bulge outward as indicated on the diaphragm. Install the heavier plate on the outside of the diaphragm and make certain that the large radius side of both plates are toward the diaphragm. Place the sealing washer between the inner diaphragm plate and the end of the rod. Tighten the capscrew to approximately 25 ft. lbs. (33.9 Newton meters). Torque while allowing diaphragm to turn freely with plates, except for EPDM rubber, use a light weight oil between the plates and diaphragm when doing this procedure. Use a wrench on the

capscrew of the opposite side to keep the rod from rotating. If the opposite chamber is assembled, the rod need not be held.

When reassembling the outer chambers and the manifold, the bolts securing the manifold flange to the chamber should be snugged prior to tightening the chamber bolts.

The sleeve and spool set is located in the valve body, which is held onto the intermediate bracket by four (4) capscrews. Loosening the four (4) hex head capscrews allows the valve body to come out of place.

Once the valve body is off the pump, remove the retaining ring holding the endcap on the body to inspect the spool and sleeve set. The spool of the air distribution valve is closely sized to the sleeve. The spool must slide freely in the sleeve. Accumulation of dirt and contaminants may prevent the spool from moving freely. It may stick in a position that prevents the pump from cycling.

Clean all parts before reassembly. Use a safety solvent and air oil to keep the parts from oxidizing. Any nicks on the spool should be removed with a fine stone or crocus cloth.

When removing the stainless steel sleeve, carefully press it out of the body, preferably using an arbor press. Reinstall it into the body until it bottoms out against the opposite end cap. Use new o-rings when reinstalling and apply a light coating of grease or o-ring lube before placing in the valve body.

Reinstall the spring, end cap, and new retaining rings. Tighten the four capscrews to eliminate air leakage. Tighten at 150 in/lbs (16.9 newton meters). Reinstall the body on the intermediate bracket with new gaskets.

A NOTE ABOUT AIR VALVE LUBRICATION

The SANDPIPER pump's pilot and main air valve assemblies are designed to operate WITHOUT lubrication. This is the preferred mode of operation. There may be instances of personal preference, or poor quality air supplies when lubrication of the compressed air supply is required. The pump air system will operate with properly lubricated compressed air supplies. Proper lubrication of the compressed air supply would entail the use of an air line lubricator (available from Warren Rupp) set to deliver one drop of 10 wt., non-detergent oil for every 20 SCFM of air the pump consumed at its point of operation. Consult the pump's published Performance Curve to determine this.

It is important to remember to inspect the sleeve and spool set routinely. It should move back and forth freely. This is most important when the air supply is lubricated. If a lubricator is used, oil accumulation will, over time, collect any debris from the compressed air. This can prevent the pump from operating properly.

Water in the compressed air supply can create problems such as icing or freezing of the exhaust air causing the pump to cycle erratically, or stop operating. This can be addressed by using a point of use air dryer to supplement a plant's air drying equipment. This device will remove excess water from the compressed air supply and alleviate the icing or freezing problem.

ESADS: Externally Serviceable Air Distribution System

Please refer to the exploded view drawing and parts list in the Service Manual supplied with your pump. If you need replacement of additional copies, contact your local Warren Rupp Distributor, or the Warren Rupp factory Literature Department at the number shown below. To receive the correct manual, you must specify the MODEL and TYPE information found on the name plate of the pump.

Models with 1" suction/discharge or larger and METAL center sections

The main air valve sleeve and spool set is located in the valve body mounted on the pump with four hex head capscrews. The valve body assembly is removed from the pump by removing these four hex head capscrews.

With the valve body assembly off the pump, access to the sleeve and spool set is made by removing four hex head capscrews (each end) on the end caps of the valve body assembly. With the end caps removed, slide the spool back and forth in the sleeve. The spool is closely sized to the sleeve and must move freely to allow for proper pump operation. An accumulation of oil, dirt or other contaminants from the pump's air supply, or from a failed diaphragm, may prevent the spool from moving freely. This can cause the spool to stick in a position that prevents the pump from operating. If this is the case, the sleeve and spool set should be removed from the valve body for cleaning and further inspection.

Remove the spool from the sleeve. Using an arbor press or bench vise (with an improvised mandrel), press the sleeve from the valve body. Take care not to damage the sleeve. At this point, inspect the o-rings on the sleeve for nicks, tears or abrasions. Damage of this sort could happen during assembly or servicing. A sheared or cut o-ring can allow the pump's compressed air supply to leak or bypass within the air valve assembly, causing the pump to leak compressed air from the pump air exhaust or not cycle properly. This is most noticeable at pump dead head or high discharge pressure conditions. Replace any of these o-rings as required or set up a routine, preventive maintenance schedule to do so on a regular basis. This practice should include cleaning the spool and sleeve components with a safety solvent or equivalent, inspecting for signs of wear or damage, and replacing worn components.

To re-install the sleeve and spool set, lightly lubricate the o-rings on the sleeve with an o-ring assembly lubricant or lightweight oil (such as 10 wt. air line lubricant). Re-install one end cap, and retaining ring (see safety warning) on the valve body. Using the arbor press or bench vise that was used in disassembly, carefully press the sleeve back into the valve body, without shearing the o-rings. You may have to clean the surfaces of the valve body where the end caps mount. Material may remain from the old gasket. Old material not cleaned from this area may cause air leakage after reassembly. Take care that the bumper stays in place allowing the sleeve to press in all the way. Reinstall the spool, opposite end cap and retaining ring (see safety warning) on the valve body. After inspecting and cleaning the gasket surfaces on the valve body and intermediate, reinstall the valve body on the pump using new gaskets. Tighten the four hex head capscrews evenly and in an alternating cross pattern.

PILOT VALVE

The pilot valve assembly is accessed by removing the main air distribution valve body from the pump and lifting the pilot valve body out of the intermediate housing.

Most problems with the pilot valve can be corrected by replacing the o-rings. Always grease the spool prior to inserting it into the sleeve. If the sleeve is removed from the body, reinsertion must be at the chamfered side. Grease the o-rings to slide the sleeve into the valve body. Securely insert the retaining ring around the sleeve. When reinserting the pilot valve, push both plungers (located inside the intermediate bracket) out of the path of the pilot valve spool ends to avoid damage.

PILOT VALVE ACTUATOR

Bushings for the pilot valve actuators are held in the inner chambers with retaining rings. An o-ring is behind each bushing. If the plunger has any sideways motion, check o-rings and bushings for deterioration/wear. The plunger may be removed for inspection or replacement. First remove the air distribution valve body and the pilot valve body from the pump. The plungers can be located by looking into the intermediate. It may be necessary to use a fine piece of wire to pull them out. The bushing can be turned out through the inner chamber by removing the outer chamber assembly. Replace the bushings if pins have bent.

TROUBLE SHOOTING

1. Pump will not cycle

- Check to make sure the unit has enough pressure to operate and that the air inlet valve is open.
- Check the discharge line to insure that the discharge line is neither closed nor blocked.
- If the spool in the air distribution valve is not shifting, check the main spool. It must slide freely.
- Excessive air leakage in the pump can prevent cycling. This condition will be evident. Air leakage into the discharge line indicates a ruptured diaphragm. Air leakage from the exhaust port indicates leakage in the air distribution valve. See further service instructions.
- Blockage in the liquid chamber can impede movement of diaphragm.

2. Pump cycles but will not pump

- Suction side of pump pulling in air. Check the suction line for air leaks and be sure that the end of the suction line is submerged. Check flange bolting. Check valve flanges and manifold to chamber flange joints.

SAFETY WARNING

To assure proper pump function and safe installation of the retaining ring, check the gap "G" dimension for full installation into the valve body grooves.

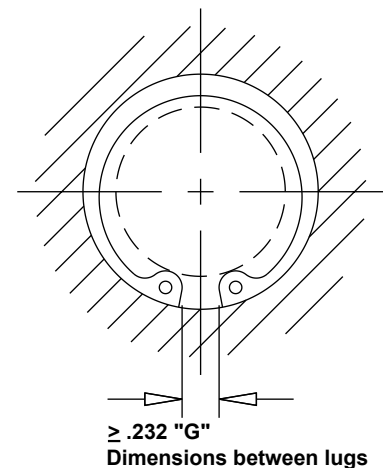

B. Make certain the suction line or strainer is not plugged. Restriction at the suction is indicated by a high vacuum reading when a vacuum gauge is installed in the suction line.

C. Check valves may not be seating properly. To check, remove the suction line and cover the suction port with your hand. If the unit does not pull a good suction (vacuum), the check valves should be inspected for proper seating.

D. Static suction lift may be too high. Priming can be improved by elevating the suction and discharge lines higher than the check valves and pouring liquid into the unit through the suction inlet. When priming at high suction lifts or with long suction lines operate the pump at maximum cycle rate.

3. Low performance

A. Capacity is reduced as the discharge pressure increases, as indicated on the performance curve. Performance capability varies with available inlet air supply. Check air pressure at the pump inlet when the pump is operating to make certain that adequate air supply is maintained.

B. Check vacuum at the pump suction. Capacity is reduced as vacuum increases. Reduced flow rate due to starved suction will be evident when cycle rate can be varied without change in capacity. This condition will be more prevalent when pumping viscous liquids. When pumping thick, heavy materials (10,000 SSU limit), the suction line must be kept as large in diameter and as short as possible, to keep suction loss minimal.

C. Low flow rate and slow cycling rate indicate restricted flow through the discharge line. Low flow rate and fast cycling rate indicate restriction in the suction line or air leakage into suction.

NOTE: Bottom chamber porting on the SA1 pump for thick liquids may create an air trap in the outer liquid chamber, causing reduced displacement and low capacity performance. Use of air vent lines from the top of the chamber back to the liquid source will correct this. Converting to top chamber porting will eliminate any possibility of an air trap in the liquid chambers.

D. Unstable cycling indicates improper check valve seating on one chamber. This condition is confirmed when unstable cycling repeats consistently on alternate exhausts. Cycling that is not consistently unstable may indicate partial exhaust restriction due to freezing and thawing of exhaust air. Use of an air dryer should solve this problem.

WARRANTY

This pump is warranted for a period of five years against defective material and workmanship. Failure to comply with the recommendations stated in this manual voids all factory warranty.

RECOMMENDED WARREN RUPP ACCESSORIES TO MAXIMIZE PUMP PERFORMANCE:

- Tranquilizer® Surge Suppressor. For nearly pulse-free flow.
- Warren Rupp Filter/Regulator. For modular installation and service convenience.
- Warren Rupp Speed Control. For manual or programmable process control. Manual adjustment or 4-20mA reception.

For more detailed information on these accessories, contact your local Warren Rupp Factory-Authorized Distributor, or Warren Rupp corporate headquarters.

IMPORTANT SAFETY INFORMATION



IMPORTANT

Read these safety warnings and instructions in this manual completely, before installation and start-up of the pump. It is the responsibility of the purchaser to retain this manual for reference. Failure to comply with the recommendations stated in this manual will damage the pump, and void factory warranty.



WARNING

Take action to prevent static sparking. Fire or explosion can result, especially when handling flammable liquids. The pump, piping, valves, containers or other miscellaneous equipment must be grounded.



WARNING

This pump is pressurized internally with air pressure during operation. Always make certain that all bolting is in good condition and that all of the correct bolting is reinstalled during assembly.



CAUTION

Before pump operation, inspect all gasketed fasteners for looseness caused by gasket creep. Retorque loose fasteners to prevent leakage. Follow recommended torques stated in this manual.



WARNING

When used for toxic or aggressive fluids, the pump should always be flushed clean prior to disassembly.



WARNING

Before maintenance or repair, shut off the compressed air line, bleed the pressure, and disconnect the air line from the pump. The discharge line may be pressurized and must be bled of its pressure.



WARNING

Before doing any maintenance on the pump, be certain all pressure is completely vented from the pump, suction, discharge, piping, and all other openings and connections. Be certain the air supply is locked out or made non-operational, so that it cannot be started while work is being done on the pump. Be certain that approved eye protection and protective clothing are worn all times in the vicinity of the pump. Failure to follow these recommendations may result in serious injury or death.



WARNING

In the event of diaphragm rupture, pumped material may enter the air end of the pump, and be discharged into the atmosphere. If pumping a product which is hazardous or toxic, the air exhaust must be piped to an appropriate area for safe disposition.



WARNING

Airborne particles and loud noise hazards. Wear ear and eye protection.

RECYCLING

Many components of SANDPIPER® AODD pumps are made of recyclable materials (see chart on page 11 for material specifications). We encourage pump users to recycle worn out parts and pumps whenever possible, after any hazardous pumped fluids are thoroughly flushed.

Grounding The Pump

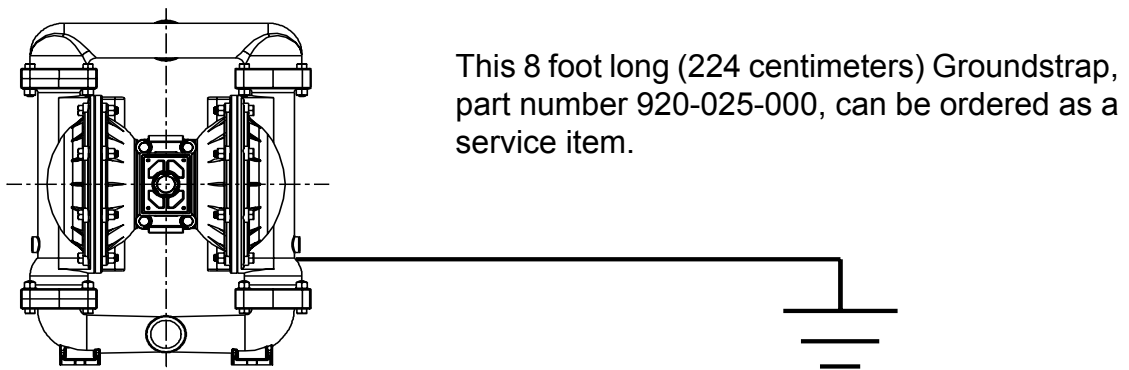
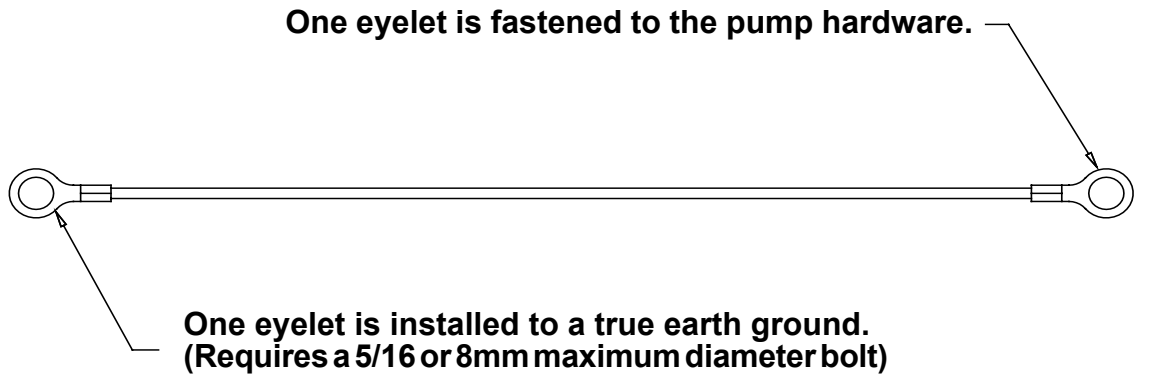

To reduce the risk of static electrical sparking, this pump must be grounded. Check the local electrical code for detailed grounding instruction and the type of equipment required, or in the absence of local codes, an industry or nationally recognized code having jurisdiction over specific installations.

MATERIAL CODES THE LAST 3 DIGITS OF PART NUMBER

000	Assembly, sub-assembly; and some purchased items	353	Geolast; Color: BLACK	557	Conductive Polypropylene; Color: BLACK; Color Coded: SILVER
010	Cast Iron	354	Injection Molded #203-40 Santoprene- Duro 40D +/-5; Color: RED	558	Conductive HDPE; Color: BLACK Color Coded: SILVER
012	Powered Metal	355	Thermal Plastic	559	Conductive Polypropylene; Color: BLACK Color Coded: SILVER
015	Ductile Iron	356	Hytrel; Color: BLUE	570	Rulon II
020	Ferritic Malleable Iron	357	Injection Molded Polyurethane; Color: GREEN	580	Ryton
025	Music Wire	358	Urethane Rubber; Color: NATURAL (Some Applications)	590	Valox
080	Carbon Steel, AISI B-1112		(Compression Mold)	591	Nylatron G-S
100	Alloy 20	359	Urethane Rubber; Color: NATURAL	592	Nylatron NSB
110	Alloy Type 316 Stainless Steel	360	Nitrile Rubber; Color Coded: RED	600	PTFE (virgin material) Tetrafluorocarbon (TFE)
111	Alloy Type 316 Stainless Steel (Electro Polished)	361	Nitrile	601	PTFE (Bronze and moly filled)
112	Alloy C	363	FKM (Fluorocarbon). Color Coded: YELLOW	602	Filled PTFE
113	Alloy Type 316 Stainless Steel (Hand Polished)	364	E.P.D.M. Rubber. Color Coded: BLUE	603	Blue Gylon
114	303 Stainless Steel	365	Neoprene Rubber; Color Coded: GREEN	604	PTFE
115	302/304 Stainless Steel	366	Food Grade Nitrile; Color: WHITE	606	PTFE
117	440-C Stainless Steel (Martensitic)	368	Food Grade EPDM; Color: GRAY	607	Envelon
120	416 Stainless Steel (Wrought Martensitic)	370	Butyl Rubber Color Coded: BROWN	608	Conductive PTFE; Color: BLACK
123	410 Stainless Steel (Wrought Martensitic)	371	Phlthane (Tuftane)	610	PTFE Encapsulated Silicon
148	Hardcoat Anodized Aluminum	374	Carboxylated Nitrile	611	PTFE Encapsulated FKM
149	2024-T4 Aluminum	375	Fluorinated Nitrile	632	Neoprene/Hytrel
150	6061-T6 Aluminum	378	High Density Polypropylene	633	FKM/PTFE
151	6063-T6 Aluminum	379	Conductive Nitrile; Color Coded: RED & SILVER	634	EPDM/PTFE
152	2024-T4 Aluminum (2023-T351)	384	Conductive Neoprene; Color Coded: GREEN & SILVER	635	Neoprene/PTFE
154	Almag 35 Aluminum	405	Cellulose Fibre	637	PTFE , FKM/PTFE
155	356-T6 Aluminum	408	Cork and Neoprene	638	PTFE , Hytrel/PTFE
156	356-T6 Aluminum	425	Compressed Fibre	639	Nitrile/TFE
157	Die Cast Aluminum Alloy #380	426	Blue Gard	643	Santoprene®/EPDM
158	Aluminum Alloy SR-319	440	Vegetable Fibre	644	Santoprene®/PTFE
159	Anodized Aluminum	465	Fibre	656	Santoprene Diaphragm and Check Balls/EPDM Seats
162	Brass, Yellow, Screw Machine Stock	500	Delrin 500	661	EPDM/Santoprene
165	Cast Bronze, 85-5-5-5	501	Delrin 570	666	FDA Nitrile Diaphragm, PTFE Overlay, Balls, and Seals
166	Bronze, SAE 660	502	Conductive Acetal, ESD-800; Color: BLACK	668	PTFE, FDA Santoprene/PTFE
170	Bronze, Bearing Type, Oil Impregnated	503	Conductive Acetal, Glass-Filled Color: BLACK; Color Coded: YELLOW		
175	Die Cast Zinc	505	Acrylic Resin Plastic		
180	Copper Alloy	506	Delrin 150		
305	Carbon Steel, Black Epoxy Coated	520	Injection Molded PVDF; Color: NATURAL		
306	Carbon Steel, Black PTFE Coated	521	Injection Molded Conductive PVDF; Color: BLACK; Color Coded: LIGHT GREEN		
307	Aluminum, Black Epoxy Coated	540	Nylon		
308	Stainless Steel, Black PTFE Coated	541	Nylon		
309	Aluminum, Black PTFE Coated	542	Nylon		
310	PVDF Coated	544	Nylon Injection Molded		
313	Aluminum, White Epoxy Coated	550	Polyethylene		
330	Zinc Plated Steel	551	Glass Filled Polypropylene; Color: BLACK		
331	Chrome Plated Steel	552	Unfilled Polypropylene; Color: NATURAL		
332	Aluminum, Electroless Nickel Plated	555	Polyvinyl Chloride		
333	Carbon Steel, Electroless Nickel Plated	556	Black Vinyl		
335	Galvanized Steel				
336	Zinc Plated Yellow Brass				
337	Silver Plated Steel				
340	Nickel Plated				
342	Filled Nylon				
351	Food Grade Santoprene; Color: NATURAL				

Delrin is a registered
tradename of E.I. DuPont.

Gylon is a registered tradename
of Garlock, Inc.

Nylatron is a registered tradename
of Polymer Corp.

Santoprene is a registered tradename
of Exxon Mobil Corp.

Rulon II is a registered tradename
of Dixon Industries Corp.

Ryton is a registered tradename
of Phillips Chemical Co.

Valox is a registered tradename
of General Electric Co.

PortaPump, Tranquizer and SludgeMaster are
registered tradenames of Warren Rupp, Inc.



SERVICE AND OPERATING MANUAL

Model SA1 Model SA25 Type 4



See Explanation of
ATEX Certification Page



ITEM NO.	PART NUMBER	DESCRIPTION	TOTAL RQD.
1	165-042-157	Cap, Valve Body (AL Center)	1
	165-042-558	Cap, Valve Body (CI Center)	1
2	360-058-360	Gasket, Valve Cap	1
3	170-063-330	Capscrew, Hex Head	1
4	170-033-330	Capscrew, Hex Head	4
5	901-035-330	Washer, Flat (AL Center)	7
	901-035-330	Washer, Flat (CI Center)	1
	900-005-330	Washer, Lock (CI Center)	6
6	901-005-330	Washer, Flat	4
7	542-001-330	Nut, Square	1
8	095-051-558	Body, Spool Valve	1
9	031-039-000	Sleeve & Spool Set	1
10	165-038-558	Cap, End	2
11	675-043-558	Ring, Retainer	2
12	560-058-360	O-Ring	8
13	360-057-360	Gasket	1
14	095-074-001	Assembly, Pilot Valve*	1
14-A	095-071-557	Valve Body	1
14-B	755-025-000	Sleeve (without O-Ring)	1
14-C	560-033-360	O-Ring (Sleeve)	4
14-D	775-014-000	Spool (without O-Ring)	1
14-E	560-023-360	O-Ring (Spool)	4
14-F	675-037-080	Retaining Ring	1
15	360-056-360	Gasket	1
16	114-007-157	Bracket, Intermediate (AL Center)	1
	114-012-010	Bracket, Intermediate (CI Center)	1
17	560-040-360	O-Ring	2
18	675-040-360	Ring, Sealing (AL Center)	2
19	720-010-375	Seal, U-Cup	2
20	070-012-170	Bearing, Sleeve	2
21	685-039-120	Rod, Diaphragm	1
22	901-012-180	Washer, Sealing	2
23	170-034-330	Capscrew, Hex Head	2
24	900-003-330	Washer, Lock (AL Wetted)	2
25	612-023-330	Plate, Outer	2
	612-101-110	Plate, Outer**	2
26	286-008-354	Diaphragm	2
	286-008-356	Diaphragm	2
	286-008-360	Diaphragm	2
	286-008-363	Diaphragm	2
	286-008-364	Diaphragm	2
	286-008-365	Diaphragm	2
27	612-022-330	Plate, Inner	2
28	132-019-360	Bumper	2
29	196-043-157	Chamber, Inner (left side) (AL Center)	1
	196-084-010	Chamber, Inner (left side) (CI Center)	1
30	196-042-157	Chamber, Inner (right side) (AL Center)	1
	196-090-010	Chamber, Inner (right side) (CI Center)	1
31	620-007-114	Plunger, Actuator	2
32	560-001-360	O-Ring	2
33	135-034-506	Bushing	2
34	675-042-115	Ring, Retainer	2
35	170-043-330	Capscrew, Hex Head (AL Center)	6
	170-006-330	Capscrew, Hex Head (CI Center)	6
36	196-012-157	Chamber, Outer	2
	196-012-110	Chamber, Outer	2
37	170-029-330	Capscrew, Hex Head	16

Repair Parts shown in **bold face (darker)** type are more likely to need replacement after extended periods of normal use. They are readily available from most Warren Rupp distributors. The pump owner may prefer to maintain a limited inventory of these parts in his own stock to reduce repair downtime to a minimum.

IMPORTANT: When ordering repair parts always furnish pump model number, serial number and type number.

ITEM NO.	PART NUMBER	DESCRIPTION	TOTAL RQD.
38	545-004-330	Nut, Hex	20
39	115-071-080	Foot Bracket	1
	115-070-330	Foot Bracket (Top Ported)	1
41***	706-013-330	Screw, Machine	4
42***	350-002-360	Foot, Rubber	4
43***	547-002-330	Nut, Stop	4
44	618-003-330	Plug, Pipe	3
44A	618-003-330	Plug, Pipe	2
	618-003-110	Plug, Pipe	2
45	132-022-360	Bumper, Actuator	2
46	312-017-335	90 Elbow 3/4" NPT (Exhaust Port) (used w/Top Ported Manifold)	1
47	170-045-330	Capscrew, Hex Head	4
48	518-015-156	Manifold	1
	518-015-110	Manifold	1
	518-059-156	Manifold (Dual Ported)	1
49	338-007-360	Flap Valve	2
	338-007-363	Flap Valve	2
	338-007-364	Flap Valve	2
	338-007-365	Flap Valve	2
50	722-021-360	Valve Seat	2
	722-021-363	Valve Seat	2
	722-021-364	Valve Seat	2
	722-021-365	Valve Seat	2
51	360-031-379	Gasket	2
	360-031-384	Gasket	2
	360-031-608	Gasket	2
52	334-013-157	Flange, Porting	2
	334-013-110	Flange, Porting	2
	334-036-156	Flange, Dual Ported	2
	334-036-110	Flange, Dual Ported	2
	334-013-157E	Flange, Porting BSP	2
	334-013-110E	Flange, Porting BSP	2
	334-036-156E	Flange, Dual Ported BSP	2
	334-036-110E	Flange, Dual Ported BSP	2
53	171-010-330	Capscrew, Flanged	4
54	905-001-015	Washer, Taper	4
55	360-030-425	Gasket, Manifold	2
	360-030-600	Gasket, Manifold (use with FKM or TFE)	2
56	807-029-330	Stud	12
	807-029-330	Stud (Dual Porting)	6
	807-054-330	Stud - Longer (Dual Porting)	6
57	900-004-330	Washer, Lock	16
58	545-004-330	Nut, Hex	12
59	530-036-000	Muffler	1
61	545-005-330	Nut, Hex (SS & Alloy C units only)	4
62	255-012-335	Coupling 3/4" NPT (Exhaust Port) (use w/Bottom Ported Manifold)	1

Items Not Shown:

031-030-558	Valve Body Assembly (Includes Items: 8, 9, 10, 11 & 12)	1
545-005-330	Nut, Hex (S.S. Only)	4
705-001-330	Drive Screw (AL Outer Chamber only)	4

Optional Item:

800-008-000	Strainer (AL Only)	1
-------------	--------------------	---

*Item 14 available in kit form. Order #031-060-000 which also includes Items 2, 13, 15, 31, & 45.

**Item 25 #612-101-110 does not require Items 23 and 24.

***Items 41, 42 & 43 noted are available in kit form only - Kit #475-221-000.

Repair Parts shown in **bold face (darker)** type are more likely to need replacement after extended periods of normal use. They are readily available from most Warren Rupp distributors. The pump owner may prefer to maintain a limited inventory of these parts in his own stock to reduce repair downtime to a minimum.

IMPORTANT: When ordering repair parts always furnish pump model number, serial number and type number.

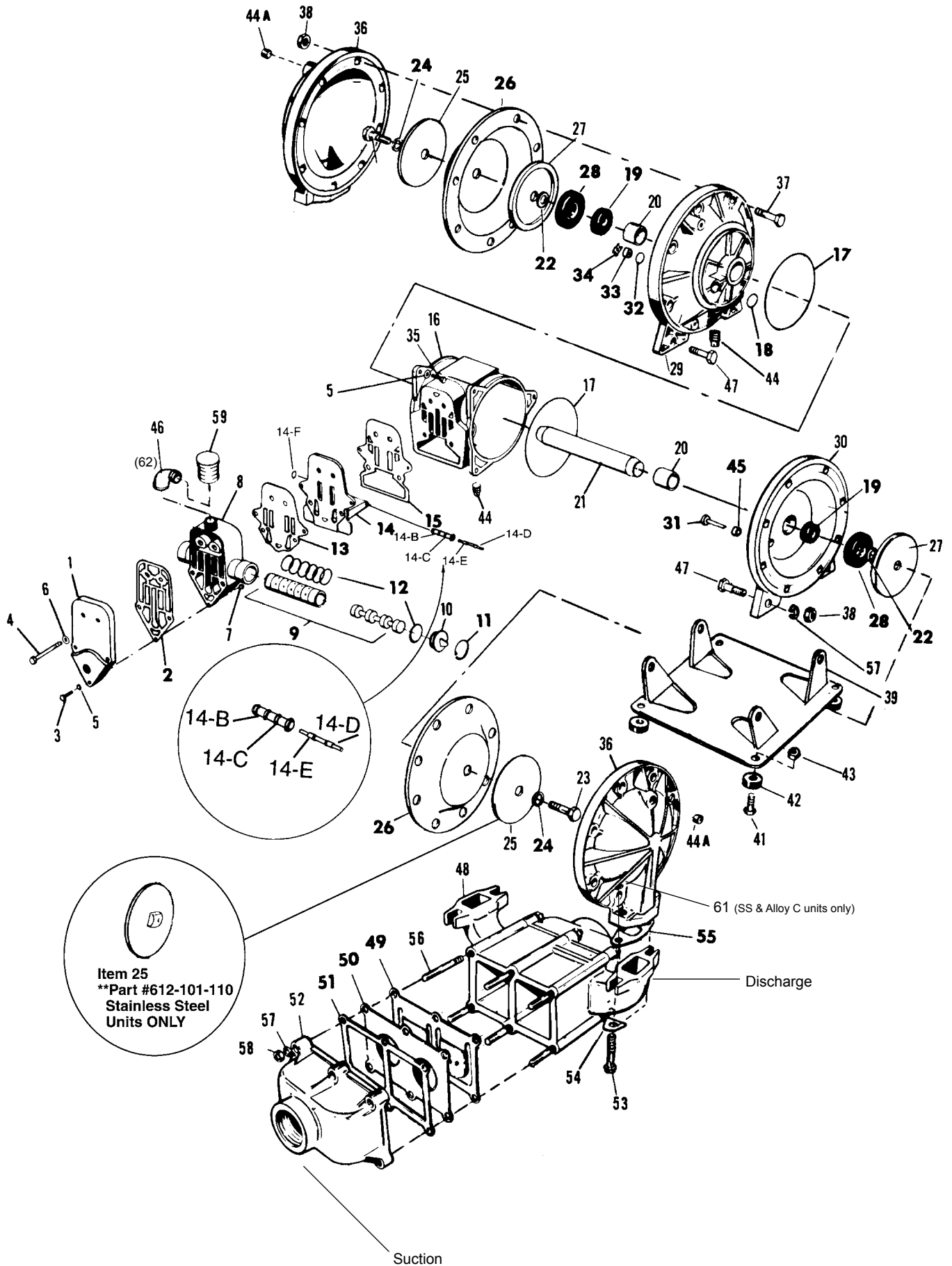

**WARREN
RUPP, INC.®**

Declaration of Conformity

Manufacturer:

**Warren Rupp, Inc.®, 800 N. Main Street, P.O. Box 1568,
Mansfield, Ohio, 44901-1568 USA**

certifies that Air-Operated Double Diaphragm Pump Series: HDB, HDF, M Non-Metallic, S Non-Metallic, M Metallic, S Metallic, T Series, G Series, RS Series U Series, EH and SH High Pressure, W Series, SMA and SPA Submersibles, and Tranquilizer Surge Suppressors comply with the European Community Directive 2006/42/EC on Machinery, according to Annex VIII. This product has used Harmonized Standard EN 809, Pumps and Pump Units for Liquids - Common Safety Requirements, to verify conformance.

David Roseberry

Signature of authorized person

David Roseberry

Printed name of authorized person

Revision Level: E

October 20, 2005

Date of issue

Engineering Manager

Title

MAY 27, 2010

Date of revision

IDEX
FLUID & METERING



Declaration of Conformity

Declaration of Conformity

WARREN RUPP, INC.[®]

EC Declaration of Conformity

In accordance with ATEX Directive 94/9/EC,
Equipment intended for use in potentially explosive environments.

Manufacturer:

Warren Rupp, Inc.[®]
A Unit of IDEX Corporation
800 North Main Street
P.O. Box 1568
Mansfield, OH 44901-1568 USA

Applicable Standard:

EN13463-1: 2001,
EN13463-5: 2003



EN 60079-25: 2004

For pumps equipped with Pulse Output ATEX Option
KEMA Quality B.V. (0344)

AODD Pumps and Surge Suppressors

For Type Examination Designations, see page 2 (back)

AODD (Air-Operated Double Diaphragm) Pumps

EC Type Examination Certificate No. Pumps: KEMA 09ATEX0071 X

KEMA Quality B.V.
Utrechtseweg 310
6812 AR Arnhem, The Netherlands

SANDPIPER[®]
A WARREN RUPP, INC. BRAND

Tranquilizer[®]

DATE/APPROVAL/TITLE:
27 MAY 2010

David Roseberry
David Roseberry, Engineering Manager

IDEX
FLUID & METERING

WARREN RUPP, INC.®

EC Declaration of Conformity

ATEX Summary of Markings

Type	Marking	Listed In	Non-Conductive Fluids	
Pump types, S1F, S15, S20, and S30 provided with the pulse output option	II 2 G Ex ia c IIC T5 II 3/2 G Ex ia c IIC T5 II 2 D Ex c iaD 20 IP67 T100°C	KEMA 09ATEX0071 X CE 0344	KEMA 09ATEX0071 X KEMA 09ATEX0071 X KEMA 09ATEX0071 X	No Yes Yes
Pump types, S1F, S15, S20, and S30 provided with the integral solenoid option	II 2 G EEx m c II T5 II 3/2 G EEx m c II T5 II 2 D c IP65 T100°C	KEMA 09ATEX0071 X CE 0344	KEMA 09ATEX0071 X KEMA 09ATEX0071 X KEMA 09ATEX0071 X	No Yes Yes
Pump types, HDB1½, HDB40, HDB2, HDB50, HDB3, HDF1, HDF25, HDF2, HDF3M, PB¼, S05, S1F, S15, S20, S30, SB1, SB25, ST1½, ST40, G15, G20, and G30, without the above listed options, no aluminum parts	II 1 G c T5 II 3/1 G c T5 II 1 D c T100°C I M1 c I M2 c	KEMA 09ATEX0071 X KEMA 09ATEX0072 X CE 0344	KEMA 09ATEX0071 X KEMA 09ATEX0071 X KEMA 09ATEX0071 X KEMA 09ATEX0071 X KEMA 09ATEX0072 X	No Yes Yes No Yes
Pump types, DMF2, DMF3, HDB1½, HDB40, HDB2, HDB50, HDB3, HDF1, HDF25, HDF2, HDF3M, PB¼, S05, S1F, S15, S20, S30, SB1, SB25, SE½, ST1, ST25, ST1½, ST40, U1F, G05, G1F, G15, G20, and G30	II 2 G c T5 II 3/2 G c T5 II 2 D c T100°C	KEMA 09ATEX0072 X CE	KEMA 09ATEX0072 X KEMA 09ATEX0072 X KEMA 09ATEX0072 X	No Yes Yes
Surge Suppressors all types	II 2 G T5 II 3/2 G T5 II 2 D T100°C	KEMA 09ATEX0073 CE	KEMA 09ATEX0073 KEMA 09ATEX0073 KEMA 09ATEX0073	No Yes Yes

EC Type Certificate No. Pumps: KEMA 09ATEX0071 X
 Type Certificate No. Pumps: KEMA 09ATEX0072 X
 Type Certificate No. Suppressors: KEMA 09ATEX0073